

Wide Range of Products for Every Need



For more information give **MISSED CALL: 07676065555**



Many of our products have BIS: ISI certification.



(DEALER COPY)

Product	Agricultural Brush Cutter	KisanKraft Invoice Date	
Brand	KisanKraft	KisanKraft Invoice No.	
Model	KK-BC4-GX50		
WARRANTY PERIOD	6 MONTHS	FOR THE SPECIFIED PERIOD FROM THE DATE OF SALE OR DELIVERY WHICHEVER IS EARLIER.	
Dealer's Invoice Date		Dealer's Invoice No.	
Buyer's Info (Name, Address, Phone, etc.):		Dealer's Stamp (Address, Phone, TIN, etc.):	
Buyer's Sign		Dealer's Sign	

Warranty Policy

What is covered: KisanKraft Limited and its manufacturers warrant this product to be free from defects in material or workmanship. All parts defective in material and workmanship are covered.

This warranty will only cover defects arising under normal usage.

This warranty is limited to repair or replacement by KisanKraft Limited or its manufacturers of such parts as appear to KisanKraft or its manufacturers, upon inspection, to be defective in material and/or workmanship. KisanKraft or its manufacturers make no warranty with respect to items not manufactured or sold by them. No onsite warranty is provided by KisanKraft Limited or its manufacturers. Defective items must be brought/sent to our Authorized Dealer or KisanKraft Limited's office for service.

What is not covered: The *warranty shall become null and void* and neither KisanKraft Limited nor any of its manufacturers, nor its authorized dealers assume any responsibility, if the failure was caused by the following:

- (1) Operation of product with incorrect fuel or lubricants,
- (2) Incorrect usage of machine or misuse,
- (3) Lack of maintenance,
- (4) Negligence,
- (5) Accident or physical damage,
- (6) Repairs made by unauthorized parties and/or with unauthorized parts,
- (7) Improper set up, adjustments, tampering or altered products
- (8) Any modification to the product what-so-ever.

Important: (1) Normal maintenance and adjustments to the product is the responsibility of the customer. (2) Normal wear and tears are not covered under warranty. (3) Rubber/plastic parts and consumables such as blades, clutch and clutch-bell, sparkplugs, nylon line, air-filters, fuel-filters, oil seals and gaskets etc. are not covered

This warranty is null & void, if you fail to register the warranty with KisanKraft by sending the KisanKraft Copy with dealer's stamp.

under the warranty. (4) Electrical Motor, Electrical Parts, Battery Etc. are not covered under the warranty.

Incidental / Consequential Loss: KisanKraft Limited or its manufacturers will not be liable for general damages, including bodily injuries, or for incidental or consequential damages including, but not limited to, loss of use, loss of profits, loss of production, expense of substitute equipment or other commercial loss or damage.

Limitation of Liability: This limited warranty is in lieu of all other express warranties, obligations, or liabilities. Any implied warranties, obligations, or liabilities, including, but not limited to, any implied warranty of merchantability shall be limited in duration to the applicable warranty period. Any action for breach of any warranties hereunder, including, but not limited to, any implied warranty of merchantability must be brought within the applicable warranty period.

Modifications of Warranty: No agent, representative, dealer, or employee of KisanKraft Limited or any of its manufacturers has the authority to increase or alter the obligations of this warranty.

Assignment / Transfer of warranty: The warranty cannot be assigned and shall not transfer if the product is resold by the first buyer. The above warranties are extended to the first end user (original purchaser), and no warranty is made, nor authorized to be made assignable on resale by the first end user.

What you must do to obtain limited warranty service: To obtain performance of any obligation under this warranty for failure during the applicable warranty period, you must deliver the defective product, to the nearest Authorized Dealer, along with proof-of-purchase (invoice/receipt). KisanKraft Limited, its manufacturers and its dealers reserve the right to inspect the claimed defective part(s) to determine if the malfunction is the result of a defect covered by this warranty. Please note that the decision of KisanKraft Limited with respect to any warranty claim is final.

After-sales Service (Including Warranty): KisanKraft Limited does not sell directly to consumers. All sales or supplies are made through Authorized Dealers. It is the responsibility of the Authorized Dealer to provide all after-sales service to consumers. Any warranty claim should be raised by the dealer to KisanKraft Limited as per warranty policy.

Jurisdiction: All disputes are subject to Bangalore court's jurisdiction.

Notes:

- This purchase is not contingent upon a product demonstration. The purchaser shall satisfy himself with the product, including any product demonstration or verification of any function, before buying. KisanKraft Limited or its authorized dealers, including online sellers, shall not be liable to give any on-site demonstration after purchase of any of the products.
- Any product once used will not be taken back by KisanKraft Limited.
- Warranty and After Sale Services (including but not limited to Installation, Demonstration, Repair, Routine Maintenance etc.), should be done through the Authorized Dealer selling this product.
- Dealers should have their own technician to provide After Sales Services to their Customers. KisanKraft Limited provides free training to Authorized Dealer's technicians at KisanKraft Limited's head office, on request from Authorized Dealer.

KisanKraft has a large range of products to serve the farmers. A list of our products is given below:

<p>Brush Cutters and Accessories</p> <ul style="list-style-type: none"> Brush Cutter/Power Weeder Backpack Brush Cutter Tea Pruner Pole pruner with Engine Reaper Attachment Blades-Circular Blades (2 & 3 points) Baffle Nylon Rope Tap & Go <p>Chainsaws</p> <ul style="list-style-type: none"> Petrol Chainsaw Electric Chainsaw Chain Sharpening Machine <p>Engines and Water Pumps</p> <ul style="list-style-type: none"> Engine –Diesel-(Horizontal) Engine –Diesel(Vertical) Engine-Kerosene Water Pump with Petrol Engine Water Pump with Kerosene Engine Water Pump with Diesel Engine <p>Hand Tools</p> <ul style="list-style-type: none"> Secateurs Folding Saw Garden Rake Garden Shovel Hedge Shear Lopper Telescopic Hedge Shear Telescopic Lopping Shear Tree Pruner Telescopic Steel Pipe & Fruit Picker Bag Sheep Shear <p>Garden Tools</p> <ul style="list-style-type: none"> Electric Pressure Washer Hedge Trimmer Lawn Mower (Electric, Petrol & Manual) Leaf Blower 	<p>Cultivators and Accessories</p> <ul style="list-style-type: none"> Petrol and Diesel <p>Sprayers and Accessories</p> <ul style="list-style-type: none"> Battery Sprayer Portable Power Sprayer Trolley Sprayer Manual Knapsack Sprayer Manual Pressure Sprayer Rose Cans Hose Crimping Machine HTP Sprayer HTP Delivery Hose HTP Hose Reel HTP Stand HTP Gun / Lance(Brass Rod) Knapsack Power Sprayer Mister / Duster / Granule Spreader HTP Sprayer Set with Diesel Engine HTP Sprayer Set with Kerosene Engine Fogging Machine <p>Milking Machine</p> <ul style="list-style-type: none"> Wood Shredder Fodder Ensiling Chaff Cutter Fodder Grinder Chaff Cutter Fodder Mini Chaff Cutter <p>Harvester</p> <ul style="list-style-type: none"> Maize Sheller Maize Sheller + Dehusker Maize Combine Harvester Onion Digger Carlotta Italy Tea Leaf Harvester Sugarcane Combine Harvester Sugarcane Leaf Stripper <p>Transplanter and Post Hole Digger</p> <ul style="list-style-type: none"> Paddy Transplanter (2 & 8 Rows) Transplanter-Vegetable & Tobacco Post Hole Digger(4" to 14" Augers)
--	---

to, loss of use, loss of profits, loss of production, expense of substitute equipment or other commercial loss or damage.

Limitation of Liability: This limited warranty is in lieu of all other express warranties, obligations, or liabilities. Any implied warranties, obligations, or liabilities, including, but not limited to, any implied warranty of merchantability shall be limited in duration to the applicable warranty period. Any action for breach of any warranties hereunder, including, but not limited to, any implied warranty of merchantability must be brought within the applicable warranty period.

Modifications of Warranty: No agent, representative, dealer, or employee of KisanKraft Limited or any of its manufacturers has the authority to increase or alter the obligations of this warranty.

Assignment / Transfer of warranty: The warranty cannot be assigned and shall not transfer if the product is resold by the first buyer. The above warranties are extended to the first end user (original purchaser), and no warranty is made, nor authorized to be made assignable on resale by the first end user.

What you must do to obtain limited warranty service: To obtain performance of any obligation under this warranty for failure during the applicable warranty period, you must deliver the defective product, to the nearest Authorized Dealer, along with proof-of-purchase (invoice/receipt). KisanKraft Limited, its manufacturers and its dealers reserve the right to inspect the claimed defective part(s) to determine if the malfunction is the result of a defect covered by this warranty. Please note that the decision of KisanKraft Limited with respect to any warranty claim is final.

After-sales Service (Including Warranty): KisanKraft Limited does not sell directly to consumers. All sales or supplies are made through Authorized Dealers. It is the responsibility of the Authorized Dealer to provide all after-sales service to consumers. Any warranty claim should be raised by dealer to KisanKraft Limited as per warranty policy.

Jurisdiction: All disputes are subject to Bangalore court's jurisdiction.

Notes:

- This purchase is not contingent upon a product demonstration. The purchaser shall satisfy himself with the product, including any product demonstration or verification of any function, before buying. KisanKraft Limited or its authorized dealers, including online sellers, shall not be liable to give any on-site demonstration after purchase of any of the product.
- Any product once used will not be taken back by KisanKraft Limited.
- Warranty and After Sale Services (including but not limited to installation, Demonstration, Repair, Routine Maintenance etc.), should be done through the Authorized Dealer selling this product.
- Dealers should have their own technician to provide After Sales Services to their Customers. KisanKraft Limited provides free training to Authorized Dealer's technicians at KisanKraft Limited's head office, on request from Authorized Dealer

User Manual



KisanKraft Limited

Factory: 818 3B1 to 818 3B18, Podalakur - Sangam Road, Prabagiripatnam, Podalakur, Nellore - 524345, Andhra Pradesh, INDIA

Head Office: Sri Huchhanna Tower, #4, 1st Main, 7-A Cross, Maruthi Layout, Dasarahalli, HAF Post, Hebbal, Bangalore 560024, Karnataka, INDIA

- ◆ Bangalore (HO) ◆ Ahmedabad ◆ Bhopal ◆ Bhubaneswar ◆ Coimbatore
- ◆ Guwahati ◆ Hubli ◆ Hyderabad ◆ Jaipur ◆ Karnal
- ◆ Kolkata ◆ Lucknow ◆ Nellore ◆ Pune ◆ Raipur



Scan the QR code to download
KisanKraft App

App is available on



Scan the QR code for
KisanKraft Youtube Channel



CONTENTS

BEFORE GETTING STARTED 7

SYMBOLS ON THE MACHINE 7

WARNING LABELS ON THE MACHINE 7

SAFETY INSTRUCTIONS 9

OPERATION 23

MAINTENANCE 26

TECHNICAL SPECIFICATION 29

EXPLODED PART DIAGRAM 30

Product	Agricultural Brush Cutter /	KisanKraft Invoice Date	
Brand	KisanKraft	KisanKraft Invoice No.	
Model	KK-BC4-GX50		
WARRANTY PERIOD	6 MONTHS	FOR THE SPECIFIED PERIOD FROM THE DATE OF SALE OR DELIVERY WHICHEVER IS EARLIER.	
Dealer's Invoice Date		Dealer's Invoice No.	
Buyer's Info (Name, Address, Phone, etc.):		Dealer's Stamp (Address, Phone, TIN, etc.):	
Buyer's Sign		Dealer's Sign	

Warranty Policy

What is covered: KisanKraft Limited and its manufacturers warrant this product to be free from defects in material or workmanship. All parts defective in material and workmanship are covered.

This warranty will only cover defects arising under normal usage.

This warranty is limited to repair or replacement by KisanKraft Limited or its manufacturers of such parts as appear to KisanKraft or its manufacturers, upon inspection, to be defective in material and/or workmanship. KisanKraft or its manufacturers make no warranty with respect to items not manufactured or sold by them. No onsite warranty is provided by KisanKraft Limited or its manufacturers. Defective items must be brought/sent to our Authorized Dealer or KisanKraft Limited's office for service.

What is not covered: The warranty shall become null and void and neither KisanKraft Limited nor any of its manufacturers, nor its authorized dealers assume any responsibility, if the failure was caused by the following:

- (1) Operation of product with incorrect fuel or lubricants, (2) Incorrect usage of machine or misuse, (3) Lack of maintenance, (4) Negligence, (5) Accident or physical damage, (6) Repairs made by unauthorized parties and/or with unauthorized parts, (7) Improper set up, adjustments, tampering or altered products (8) Any modification to the product what-so-ever.

Important: (1) Normal maintenance and adjustments to the product is the responsibility of the customer. (2) Normal wear and tear are not covered under warranty. (3) Rubber/plastic parts and consumables such as blades, clutch and clutch-bell, sparkplugs, nylon line, air-filters, fuel-filters, oil seals and gaskets etc. are not covered under the warranty. (4) Electrical Motor, Electrical Parts, Battery Etc. are not covered under the warranty.

Incidental / Consequential Loss: KisanKraft Limited or its manufacturers will not be liable for general damages, including bodily injuries, or for incidental or consequential damages including, but not limited

10-5	6 quare screws	M5-06183-86	4	
10-6	"+" screws	M5X25-09074. 4	2	
10-7	6 angles screws	M5-G841-86	2	
10-8	cutting tine plate	BC415.3.1-1	4	
10-9	Plastic. parts for guard	BC4152.01-1	2	
12	Gear case ass'	BC415		
12-1	Backstop ring	26-GB194.2-86	1	142001010
12-2	Backstop ring	10-GB393.1-86	1	141903020
12_3	Needle bearing	6000-211S	3	140102020
12-4	Initiative Gear	3C305. 2. 3-3	1	120051300
124	6 square screws	N5-086183-86	I	
12-6	Inner 6 angles screws	N6i16-09074.x	1	140203030
12-7	Inner 6 angles screw.	"111-09074. x	1	140803010
12-8	Gear case	1C415. 2. 3-2	1	130070201
12-9	Passive gear	3C305. 2. 3-4	1	120051200
12-10	Spline shaft	3C305. 2. 3-1	1	120320100
12-11	Needle bearing	6002-2150/7276	1	140104020
12-12	Backstop ring	32-GB193.246	I	.42003010
12-13	Protect ing cap	BC305. 2-1	1	120180500
12-14	Washer of shaft	Nal 2-2	1	120170500
12_15	Press board of blade	80305. 2-3	7	120170600
12-16	Oil seal	0201032E1	1	150151700
12-17	Protect ing cover	80305. 2-4	1	120400200
12-18	Left-turn screws	30305.2-5	7	120420400
12-19	6 angles screws	EX25-GB9074.X	2	140802040
12-20	6 angles screws	M5X12-010074 . X	3	140802010
1-A	blades	BC305.4-I	1	
1-B	Nylon cutter ass'	BC305	I	150370301

Product	Agricultural Brush Cutter /	KisanKraft Invoice Date	
Brand	KisanKraft	KisanKraft Invoice No.	
Model	KK-BC4-GX50		
WARRANTY PERIOD	6-MONTHS	FOR THE SPECIFIED PERIOD FROM THE DATE OF SALE OR DELIVERY WHICHEVER IS EARLIER.	
Dealer's Invoice Date		Dealer's Invoice No.	
Buyer's Info (Name, Address, Phone, etc.):		Dealer's Stamp (Address, Phone, TIN, etc.):	
Buyer's Sign		Dealer's Sign	

Warranty Policy

What is covered: KisanKraft Limited and its manufacturers warrant this product to be free from defects in material or workmanship. All parts defective in material and workmanship are covered. This warranty will only cover defects arising under normal usage. This warranty is limited to repair or replacement by KisanKraft Limited or its manufacturers of such parts as appear to KisanKraft or its manufacturers, upon inspection, to be defective in material and/or workmanship. KisanKraft or its manufacturers make no warranty with respect to items not manufactured or sold by them. No onsite warranty is provided by KisanKraft Limited or its manufacturers. Defective items must be brought/sent to our Authorized Dealer or KisanKraft Limited's office for service.

What is not covered: The warranty shall become null and void and neither KisanKraft Limited nor any of its manufacturers, nor its authorized dealers assume any responsibility, if the failure was caused by the following:

(1) Operation of product with incorrect fuel or lubricants, (2) Incorrect usage of machine or misuse, (3) Lack of maintenance, (4) Negligence, (5) Accident or physical damage, (6) Repairs made by unauthorized parties and/or with unauthorized parts, (7) Improper set up, adjustments, tampering or altered products (8) Any modification to the product what-so-ever.

Important: (1) Normal maintenance and adjustments to the product is the responsibility of the customer. (2) Normal wear and tear are not covered under warranty. (3) Rubber/plastic parts and consumables such as blades, clutch and clutch-bell, sparkplugs, nylon line, air-filters, fuel-filters, oil seals and gaskets etc. are not covered under the warranty. (4) Electrical Motor, Electrical Parts, Battery Etc. are not covered under the warranty.

Incidental / Consequential Loss: KisanKraft Limited or its manufacturers will not be liable for general damages, including bodily injuries, or for incidental or consequential damages including,

but not limited to, loss of use, loss of profits, loss of production, expense of substitute equipment or other commercial loss or damage.

Limitation of Liability: This limited warranty is in lieu of all other express warranties, obligations, or liabilities. Any implied warranties, obligations, or liabilities, including, but not limited to, any implied warranty of merchantability shall be limited in duration to the applicable warranty period. Any action for breach of any warranties hereunder, including, but not limited to, any implied warranty of merchantability must be brought within the applicable warranty period.

Modifications of Warranty: No agent, representative, dealer, or employee of KisanKraft Limited or any of its manufacturers has the authority to increase or alter the obligations of this warranty.

Assignment / Transfer of warranty: The warranty cannot be assigned and shall not transfer if the product is resold by the first buyer. The above warranties are extended to the first end user (original purchaser), and no warranty is made, nor authorized to be made assignable on resale by the first end user.

What you must do to obtain limited warranty service: To obtain performance of any obligation under this warranty for failure during the applicable warranty period, you must deliver the defective product, to the nearest Authorized Dealer, along with proof-of-purchase (invoice/receipt). KisanKraft Limited, its manufacturers and its dealers reserve the right to inspect the claimed defective part(s) to determine if the malfunction is the result of a defect covered by this warranty. Please note that the decision of KisanKraft Limited with respect to any warranty claim is final.

After-sales Service (Including Warranty): KisanKraft Limited does not sell directly to consumers. All sales or supplies are made through Authorized Dealers. It is the responsibility of the Authorized Dealer to provide all after-sales service to consumers. Any warranty claim should be raised by dealer to KisanKraft Limited as per warranty policy.

Jurisdiction: All disputes are subject to Bangalore court's jurisdiction.

Notes:

- This purchase is not contingent upon a product demonstration. The purchaser shall satisfy himself with the product, including any product demonstration or verification of any function, before buying. KisanKraft Limited or its authorized dealers, including online sellers, shall not be liable to give any on-site demonstration after purchase of any of the product.
- Any product once used will not be taken back by KisanKraft Limited.
- Warranty and After Sale Services (including but not limited to installation, Demonstration, Repair, Routine Maintenance etc.), should be done through the Authorized Dealer selling this product.
- Dealers should have their own technician to provide After Sales Services to their Customers. KisanKraft Limited provides free training to Authorized Dealer's technicians at KisanKraft Limited's head office, on request from Authorized Dealer.

1	Stop line		1	
-2	Throttle line		1	
3	Single shoulder strap		1	170060202
4	Singe double strap ass'		1	170064040
1	Connector plates		1	
1	Clutch plate 7T	BC305.2.114	1	120070200
2	Backstop ring	35-GB94..2-86	1	14200401012-19
3	Need le gearing 6202-215-GB1'176	6202-2RS-GBT276	1	140106020
4	Backstop ring 15-01893.246	15-GB893.2-86	1	141906010
5	Connecting plates 36415.2.1-1	BC415.2.1-1	1	130080701

No.	Name	Drawing No.	QTY	Remark
9-6	Shock rubber	BC415. 2. 1-2	1	150300900
9-7	"C" clamp A	60415.2.1-3	1	130090201
9-8	"C" clamp B	BC415. 2. 1-4	1	130090101
9-9	Inner 6 angles screws	M5x25-09014. x	2	140802040
9-10	Inner 6 angles screws	M6x20-0B9014.1	4	
9-11	Inner 6 angles screws	M5X12-09074.x	1	140802010
10-1	Safety guard	BC415. 2. 0	1	150461901
10_2	Localizes for safety guard	BC41S.2.11	1	150241110
10-3	Connecting board or safety Guard	BC415/R.2.1-1	1	120452200
10-4	"+" screws	115x22-0B9014.4	4	

4	Square screws	M6-6839	2	141202010
1.	Oil bearing	BC415_04	5	150150300
2	Shaft parts	08 1530 2 2-1	1	12003080010-1
3	Aluminium pipe	02183Nn02 2-2	1	130120401
	P type handles			
1	4-square screws	M5GB39-18	2	141301020
2.	handles protection	GL_03B-03 -0	1	150210100
5.	"D" handle	GL_03B-04	1	150210300
1	lock	GL_0313-02A	2	120261001
2	handles protection	GL_03B-03	1	150210100
ω	"D" handle	GL_03B-04	1	15021030011
4	lock	GL_038-02A	2	120281001
5	- "+" screws	145828-GB9074_4	2	14050309018
-1	Right grip arts'	(BC415_3_1-2Y)	1	150090500
-2	Right handle	(BC415_3_1-7)	1	130130700
3	Localizes for handle	BC415_3-2	1	130100101
4	Down press board	BC415_3-1	1	130110201
'5	Inner 6 angles screws 145X25-GB9074.x	145X25-GB9074.x	6	140802040
4	Left handles	(BC415_3_1-2)	1	130130207
-7	Left grip	(BC415_3_1-22)	1	150090900
8	Upper press board	BC415-3-3	1	130110101
	Hanger link ass' •		1	
1	Hanger link for sack 0C415_2_-10	BC415.2-10	1	150243400
2	Local izer link BC415.2- 71	BC415.2-71	1	150260100
3	6 angles screws 1454341-136	M5X20-GB41-86	1	141202010
4	"+" heads screws	M5X20-GB818-85	1	140603050
	Single-hand grip ass' BC415_3_1-3	BC415_3_1-3	1	15009100112

BEFORE GETTING STARTED

Before using the machine for the first time be sure to read through this manual in order to avoid wrong operation. Please preserve this manual properly so that it can provide you with information whenever necessary.

SYMBOLS ON THE MACHINE

For safe operation and maintenance, symbols are carved in relief on the machine. According to these indications, please be careful not to make a mistake.

WARNING LABELS ON THE MACHINE



Warning / Attention



Danger: Risk of fire or explosion



Read the instruction manual completely and carefully before using the tool.



Top speed of trimmer head is 6600 min⁻¹



Wear head, eye and ear protection.



Top speed of blade is 7100 min⁻¹



Wear protective gloves.



The port to refuel the "MIX FUEL"



Wear safety footwear



The guaranteed noise level



Danger: Troughing the rotating blade is forbidden.



With this symbol the manufacturer confirms that this tool is in accordance with applicable European directives.



Beware of thrown objects.



Hot surface: Risk of burn.



Keep away from fire



Keep all children, bystanders, and helpers 15 meters away from the brush cutter

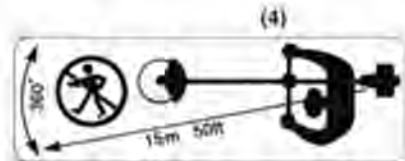

Never modify your Brush Cutter. We won't warrant the machine, if you use the remodeled Brush Cutter or you don't observe the proper usage written in the manual

CHOKE OPERATION



Starting mode when the engine is hot (choke off)
Position: AIR CLEANER COVER



Starting mode when the engine is cold (choke on).
Position: AIR CLEANER COVER

! IMPORTANT

If warning label peel off or become soiled and impossible to read, you should contact the dealer from whom you purchased the product to order new labels and affix them in the required location(s).

! WARNING

Never modify your brush cutter. We won't warrant the machine, if you use the remodeled brush cutter or you don't observe the proper usage written in the manual.

4-8	BC415. 3.1-2Z)	1	130110101	12-6	146X I 6489074. x	1	140803030
s		1		12-7	u6x12- 689074. x	1	140803010
5-1	8C415.2-10	1	150243400	12-8	60415.2.3-2	1	130070201
5-2	BC415.2-11	1	150260100	12-9	8C305. 2.3-4	1	120051200
5-3	M5-841-86	1	141202010	12-10	80305.2.3-1	1	120320100
5-4	M5x20-GB818-85	1	140603050	12-11	6002- 2RS0B/T276	1	140104020
6	BC415. 3. 1-3	1	15009100112	-12	32-0B893.2- 86	1	142003010
6-1		1		12-13	BC305.2-1	1	120180500
6-2		1		12-14	8C305.2-2	1	120170500
7		1	170060202 / 170064040	12-15	BC305. 2-3	1	120170600
8		1		12-16	φ20Xφ32X7	1	150151700
9		1		12-17	BC305. 2-4	1	120400200
9-1	BC305.2.11A	1	120070200	12-18	BC305. 2-5	1	120420400
9-2	35-GB894, 2-86	1	142004010	12-19	M5X25- GB9074.X	2	140502040
9-3	(15X35X11)	1	140106020	12-20	M5X12- GN9074.X	3	140802010
9-4	15-GB893. 2-86	1	141906010		BC305. 4-1	1	
9-5	BC415. 2. 1-1	1	130080701		BC305	1	150370301

No.	Name	Drawing No.	QTY	Remark
	Small salty guards			
1	"+" head screws	M6X18-GB818-85		1144(2)620044005100
5	Spring creation	6-GB818-85		142204010
2	Press board for safety Garuds	BC415. 2.0.1	1	120441800
3	Cover of safety guard	BC415.2.0A	1	150461500

Part No.	Name	Qty	Remarks	Part No.	Name	Qty	Remarks
1				9-6	BC415.2.1-2	1	150300900
1-1	M6x18-613318-85	2	140604050	9_7	BC415.2.1-3	1	130090201
1-5	6-G6895	2	142204010				
1-2	BC415.2.0.1	1	120441800	9-8	BC415.2.1-4	1	130090101
1-3	BC415.2.0A	1	150461500	9-9	M5x25-GB9014.x	2	140802040
1-4	M6-GB39	2	141202010	9-10	M6x20-GB9014.x	4	
2-1	BC415.04	5	150150300	9-11	M5X12-GB19074.x	1	140802010
2-2	φ 8X 1530 BC415.2.2-1	1	120030800	10-1	BC415.2.0	1	150461901
2-3	φ28x1500 BC-415.2.2-2	1	130120401	10_2	BC415.2.11	1	150241110
3				10-3	Bc415/1.2.1-1	1	120452200
3-1	M5GB39	2	141301020	10-4	M5x22-GB9074.4-88	4	
3-2	03B-03	1	150210100	10_5	M5-GB6183-86	4	
3-3	0311-04	1	150210300	10-6	M5x25-GB9074.4-88	2	
3-4	03B-02A	2	120281001	10-7	M5-GB41-86	2	
3-5	M5X28-GB 9074.4	2	140503090	10-8	BC415.3.1-1	1	120452100
4-1	(BC415.3.1-2Y)	1	15009050010	-9	BC415.2.0.1	1	150461600
4-2	(BC415.3.1-Y)	1	130130700	12	BC415		
4-3	BC415.3-2	1	130100101	12-1	26-CH94.2-86	1	142001010
4-4	BC415.3-1	1	130110201	12-2	10-013893.2-86	1	141903020
4-5	M5X25-GB9074.x	6	140802040	12-3	6000-211S	3	140102020
4-6	OM I 5.3.1-2)	1	130130201	12-4	BC305.2.3-3	1	120051300
4-7	(BC4 1 5.3.1-Z)	1	150090900	12-5	M5-GB6183-86	1	

SAFETY INSTRUCTIONS



1. Read this manual carefully until you completely understand and follow all safety and operating instructions.
2. Keep this manual handy so that you may refer to it later whenever any questions arise. Also note, if you have any questions which cannot be answered herein, contact the dealer from whom you purchased the product.
3. Always be sure to include this manual when selling, lending, or otherwise transferring the ownership of this product.
4. Never allow children or anyone unable to fully understand the directions given in the manual to use the machine.



Working Condition



1. When using the product, you should wear proper clothing and protective equipment:
 - (1) Helmet
 - (2) Ear protectors
 - (3) Protection goggles or face protector
 - (4) Thick work gloves
 - (5) Non-slip-sole work boots
2. And you should carry with you:
 - (1) Attached tools and files
 - (2) Properly reserved fuel
 - (3) Spare blade
 - (4) Things to notify your working area (rope, warning signs)
 - (5) Whistle (for collaboration or emergency)
 - (6) Hatchet or saw (for removal of obstacles)



3. Do not wear loose clothing, jewelry, short trousers, sandals, or go barefoot. Do not wear anything which might be caught by a moving part of the unit. Secure hair so it is above shoulder length.

Working Circumstance



1. Never start the engine inside a closed room or building. Exhaust gases contain dangerous carbon monoxide.
2. Never use the product,
 - a) When the ground is slippery or when you can't maintain a steady posture.



- b) At night, at times of heavy fog, or at any other times when your field of vision might be limited, and it would be difficult to gain a clear view of the working area.
- c) During rainstorms, during lightning storms, at times of strong or gale-force winds, or at any other times when weather conditions might make it unsafe to use the product.

Working Plan



1. You should never use the product when under the influence of alcohol, when suffering from exhaustion or lack of sleep, when suffering from drowsiness as a result of having taken cold medicine or at any other time when a possibility exists that your judgment might be impaired or that you might not be able to operate the product properly and in a safe manner.



2. When planning your work schedule, allow plenty of time to rest. Limit the amount of time over which the product is to be used continuously to somewhere around 30~40 minutes per session, and take 10~20 minutes of rest between work sessions. Also try to keep the total amount of work performed in a single day under 2 hours or less.

WARNING



1. If you don't observe the working time, or working manner, Repetitive Stress Injury (RSI) could occur. If you feel discomfort, redness and swelling of your fingers or any other part of your body, see a doctor before getting worse.
2. To avoid noise complaints, in general, operate product between 8a.m. and 5p.m. on weekdays and 9a.m. to 5p.m. during Weekends.



NOTE:

Check and follow the local regulations as to sound level and hours of operations for the product.

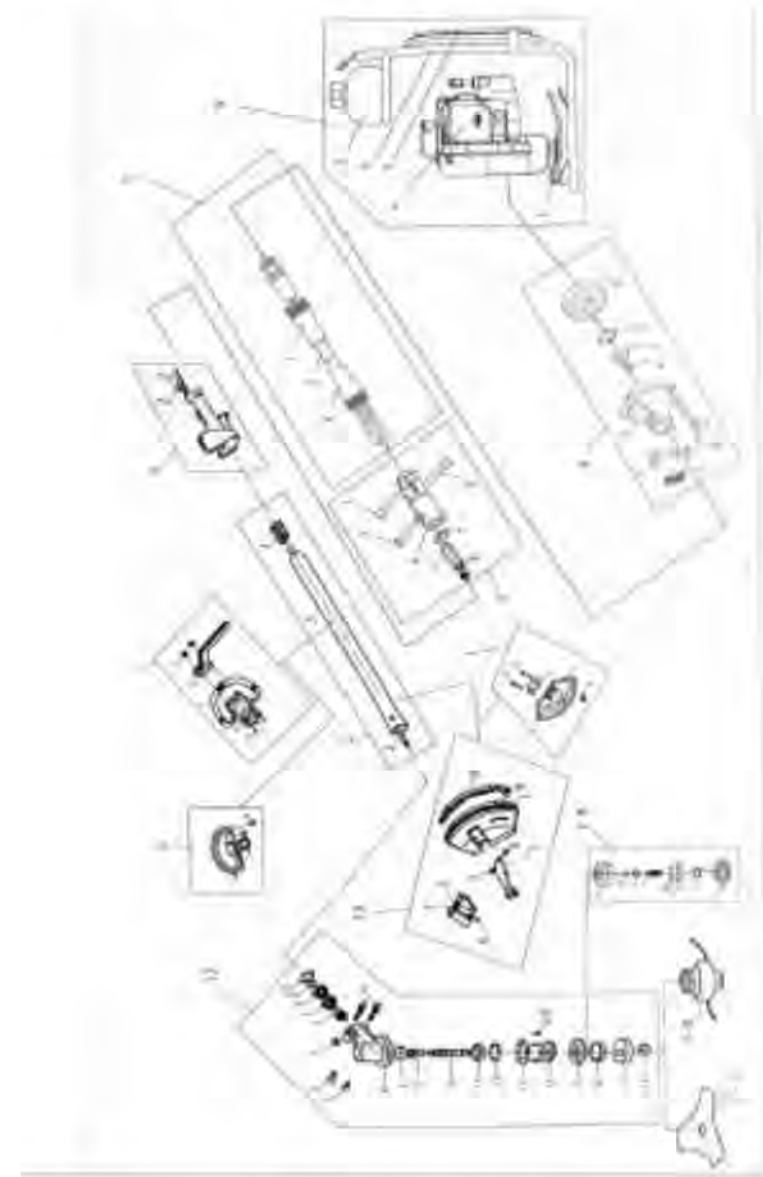

S.NO	KK-P-No	KK-Part Name	Qty
H	BH	Gear Case Assy	
1	BH-1	Stop Ring 26-Inner	1
2	BH-2	Stop Ring 10-Outer	1
3	BH-3	Bearing 6000- 2 RS	1
4	BH-4	Bearing-6000	2
5	BH-5	Pinion	1
6	BH-6	Screw M6x20-Allen	1
7	BH-7	Screw M5x12-Hex	1
8	BH-8	Screw M5x12-Hex	3
9	BH-9	Grease Bolt-M5x12	1
10	BH-10	Gear Case	1
11	BH-11	Blade Cover	1
12	BH-12	Gear	1
13	BH-13	Gear Shaft	1
14	BH-14	Bearing 6002-2 RS	1
15	BH-15	Stop Ring 32-Inner	1
16	BH-16	Holder-A	1
17	BH-17	Holder-B	1
18	BH-18	Washer 10-Star	1
19	BH-19	Nut M10-Left Thread	1
20	BH-20	Split Pin 2x16	1

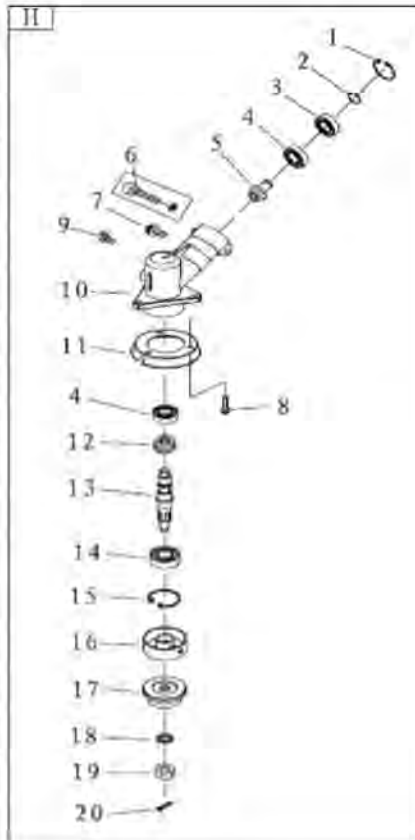

Before Starting the Engine



1. The area within a perimeter of 50 feet (15m) of the person using the product should be considered a hazardous area into which no one should enter. If necessary, yellow warning rope, warning signs should be placed around the perimeter of the area. When work is to be performed simultaneously by two or more persons, care should also be taken to constantly look around or otherwise check for the presence and locations of other people working so as to maintain a distance between each person sufficient to ensure safety.
2. Check the condition of working area to avoid any accident by hitting hidden obstacles such as stumps, stones, cans, or broken grass.

IMPORTANT

- Remove any obstacle before beginning work.
3. Inspect the entire unit for loose fasteners and fuel leakage. Make sure that the cutting attachment is properly installed and securely fastened.
4. Be sure the debris guard is firmly attached in place.
5. If the cutting head is the metal blade, use the shoulder strap. Adjust the strap for comfort before starting the engine. The strap should be adjusted so the left hand can comfortably hold the handlebar grip approximately waist high.

Starting the Engine



1. Keep bystanders and animals at least 50feet (15m) away from the operating point. If you are approached, immediately stop the engine.
2. The product is equipped with a centrifugal clutch mechanism, so the cutting attachment begins to rotate as soon as the engine is started by putting the throttle into the start position. When starting the engine, place the product onto the ground in a flat clear area and hold it firmly in place so as to ensure that neither the cutting part nor the throttle come into contact with any obstacle when the engine start.

⚠️ WARNING: Never place the throttle into the high-speed position when starting the engine.

3. After starting the engine, check to make sure that the cutting attachment stops rotating when the throttle is moved fully back to its original position. If it continues to rotate even after the throttle has been moved fully back, turn off the engine and take the unit to your authorized servicing dealer for repair.

Using the Product

⚠️ IMPORTANT

Cut only materials recommended by the manufacturer. And use only for tasks explained in the manual.



1. Grip the handles firmly with both hands using your whole hand. Place your feet slightly apart (slightly further apart than the width of your shoulders) so that your weight is distributed evenly across both legs, and always be sure to maintain a steady, even posture while working.
2. Keep cutting attachment below waist level.
3. Maintain the speed of the engine at the level required to perform cutting work, and never raise the speed of the engine above the level necessary.
4. If the unit start to shake or vibrate, turn off the engine and check the whole unit. Do not use it until the trouble has been properly corrected.
5. Keep all parts of your body away from rotating cutting attachment and hot surfaces.

S.NO	KK-P-No	KK-Part Name	Qty
L	BL		1
M	BM	Throttle Wire Assy	1
N	BN	Wire Sleeve	1
P	BP	Wire Clamp Band	3



S.NO	KK-P-No	KK-Part Name	Qty
I	I		1
1	BI-1	Screw M6 x 25 (Hex)	2
2	BI-2	Safety Guard Bracket	1
3	BI-3	Safety Guard	1

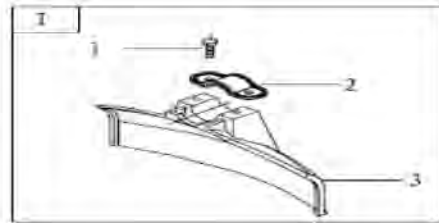

S.NO	KK-P-No	KK-Part Name	Qty
J	J		
1	BJ-1	Cap, Lower	1
2	BJ-2	Holder Rubber Cover	1
3	BJ-3	Holder	1
4	BJ-4	Screw M5 x 30(Allen)	4

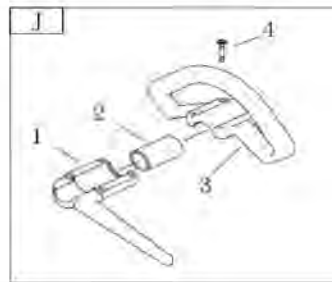

S.NO	KK-P-No	KK-Part Name	Qty
K	BK	Lever ASS'Y	
1	BK-1	Screw M5 x 20(Star)	2
2	BK-2	N/A	1
3	BK-3	N/A	1
4	BK-4	N/A	1
5	BK-5	N/A	1
6	BK-6	N/A	1
7	BK-7	N/A	1
8	BK-8	N/A	1
9	BK-9	Nut M5	2
10	BK-10	N/A	1
11	BK-11	Switch On/Off	1



- Never touch the muffler, spark plug, or other metallic parts of the engine while the engine is in operation or immediately after shutting down the engine. Doing so could result in serious burns or electrical shock.

If Someone Comes



- Guard against hazardous situations at all times. Warn adults to keep pets and children away from the area. Be careful if you are approached. Injury may result from flying debris.
- If someone calls out or otherwise interrupts you while working, always be sure to turn off the engine before turning around.

Maintenance



- In order to maintain your product in proper working order, perform the maintenance and checking operations described in the manual at regular intervals.
- Always be sure to turn off the engine before performing any maintenance or checking procedures.

⚠️ WARNING

The metallic parts reach high temperatures immediately after stopping the engine.

- Under no circumstances should you ever take apart the product or alter it in any way. Doing so might result in the product becoming damaged during operation or the product becoming unable to operate properly.

Handling Fuel



- The engine of the product is designed to run on a mixed fuel which contains highly flammable petrol. Never store cans of fuel or refill the tank of the unit in any place where there is a boiler, stove, wood fire, electrical sparks, welding sparks, or any other source of heat or fire which might ignite the fuel.
- Never smoke while operating the unit or refilling its fuel tank.
- When refilling the tank, always turn off the engine and allow it to cool down. Take a careful look around to make sure that there are no sparks or open flames anywhere nearby before refueling.
- Wipe spilled fuel completely using a dry rag if any fuel spillage occurs during refueling.
- After refueling, screw the fuel cap back tightly onto the fuel tank and then carry the unit to a spot 10feet (3m) or more away from where it was refueled before turning on the engine.

Transportation



1. When hand-carrying the product, cover over the cutting part, if necessary, lift up the product and carry it paying attention to the blade.
2. Never transport the product over rough roads over long distances by vehicle without removing all fuel from the fuel tank. If doing so, fuel might leak from the tank during transport.

PRODUCT FEATURES

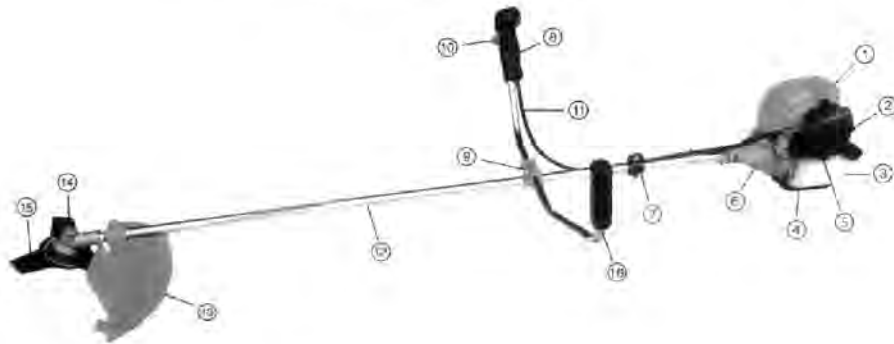

1. Cylinder cover
2. Starter
3. Petrol tank
4. Engine stand
5. Air cleaner
6. Housing
7. Shoulder strap mountings
8. Control handle
9. Handle bracket
10. Throttle control lever
11. Throttle cable
12. Outer shaft with inner drive shaft
13. Safety guard
14. Blade
15. Handle
16. Brush cutter trimmer gear case

S.NO	KK-P-No	KK-Part Name	Qty
E			1
1	BE-1	Rubber Bush (Outer Pipe)	4
2	BE-2	Oil-bearing	4
3	BE-3	Drive Shaft	1
4	BE-4	Outer Pipe with Bush	1
5	BE-5	Adapter Comp.	1

S.NO	KK-P-No	KK-Part Name	Qty
F	F		
1	BF-1	Flexible Shaft/Inner Cable	1
2	BF-2	Flexible Liner COMP.	1

S.NO	KK-P-No	KK-Part Name	Qty
G	G		
1	BG-1	Screw M5 x 12 (Allen)	1
2	BG-2	Joint Pipe	1
3	BG-3	Screw M5 x 30(Star)	1
4	BG-4	Screw M5 x 20 (Allen)	1

S.NO	KK-P-No	KK-Part Name	Qty
C	C		
1	BC-1	Shoulder Plate COMP	1
2	BC-2	Holder, Lower	2
3	BC-3	Screw M5 x 16 (Hex)	6
4	BC-4	Holder, Upper	2

S.NO	KK-P-No	KK-Part Name	Qty
D	BD	Clutch COMP	1
1	BD-1	Lock Pin	1
2	BD-2	Clutch Case/Linker	1
3	BD-3	Spring (Lock Pin)	1
4	BD-4	Stop Ring 5 Outer	1
5	BD-5	Clutch COMP.	1
6	BD-6	Stop Ring 35 Inner	1
7	BD-7	Bearing 6202-2RZ/P6	1
8	BD-8	Stop Ring 15 Outer	1

WARNING LABELS ON THE MACHINE

(1) (2) (3) (4)



- (1) Read **owner's manual before operating** this machine
- (2) Wear head, eye, and ear protection.
- (3) **Warning/Attention.**
- (4) Keep all children, bystanders, and helpers 15 meters away from the brush Cutter.

If warning seals peel off or become soiled and impossible to read, you should contact the dealer from which you purchased the product to order *new* seals and affix the new seal in the required location.

Never modify this machine.

Any modification to this machine will invalidate your warranty.

SYMBOLS ON THE MACHINE

- For safe operation and maintenance, symbols are carved in relief on the machine.
- (a) Put petrol here (use **ONLY** unleaded fuel).
Position: FUEL TANK CAP
 - (b) Cold Start (Choke On)
Position: AIR CLEANER COVER
 - (c) Warm Start/Run Position (Choke Off.) Position: AIR CLEANER COVER

THINGS TO CHECK BEFORE USING YOUR BRUSHCUTTER

- a. Before beginning work, look around carefully to get a feel for the shape of the land, or grass to be trimmed and whether or not there are any obstacles which might get in the way while working. Remove any obstacles.
- b. The area within a perimeter of 15m of the person using the brush cutter should be considered a hazardous area into which no one should enter while the brush cutter is in use, and when necessary, a yellow warning rope/ warning signs should be placed around the work area. When work is to be performed simultaneously by two or more persons,



placed around the work area. When work is to be performed simultaneously by two or more persons,

always check the presence and locations of others so as to maintain a distance between each person sufficient to ensure safety.

- c. Make sure that there are no loose screws or bolts, fuel leaks, ruptures, dents, or any other problems, which might interfere with safe operation. Be especially careful to check that there is nothing wrong with the blades or with the joints by which the blades are attached to the brush cutter.



- d. Never use blades that are bent, warped, cracked, broken or damaged in any way.
- e. Always keep the blade sharp.
- f. Check the bolt to fasten the blade is fully tightened and be sure, the blade turns smoothly without any abnormal noise.



S.NO	KK-P-No	KK-Part Name	Qty
A			
1	BA-1	Shoulder Belt ASSY's	1
2	BA-2	Shoulder Frame COMP.	1
3	BA-3	Spring (Bedding)	3
4	BA-4	Nut M6 (Flanged Hex)	6
5	BA-5	Screw M6 x 16 (Hex)	6

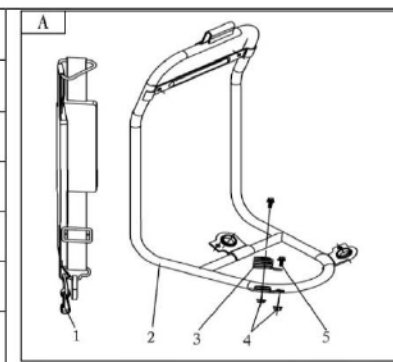

S.NO	KK-P-No	KK-Part Name	Qty
B	B		
1	BB-1	Down base	1
2	BB-2	Nut M10 (Flanged Hex)	1
3	BB-3	Screw M 6x25 (Star)	1
4	BB-4	Washer-6 Plain	1
5	BB-5	Nut M6	1
6	BB-6	N/A	1
7	BB-7	Engine Base	1

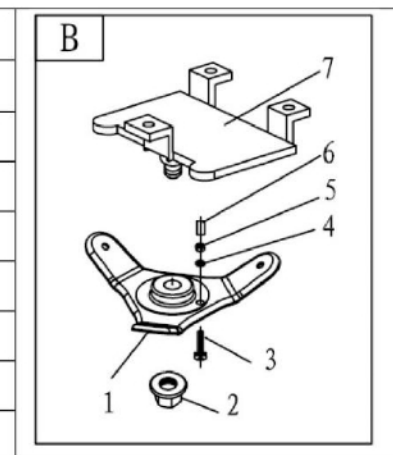

17	Wave OIL SEAL	2	47	CLUTCH SHOE SCREW	2	77	FUEL TANK ASSEMBLY	1
18	MUFFLER DUAL-HEAD SCRE	2	48	CLUTCH ASSEMBLY	1	78	FUEL TANK LID ASSEMBLY	1
19	EXHAUST WIND BOARD	1	49	SCREW 145.20	3	79	FUEL TANK BRACKET	1
20	MUFFLER ASSEMBLY	1	50	FAN COVER	1	80	SCREW M5*15	2
21	M5	2	51	SCREW M015	2	81	ANTI-VIBRATION GASKET	4
22	SCREW 145o15	2	52	SCREW 148	2	82	φ15.3	2
23	EXHAUST CAMROCKER	1	53	COIL ASSEMBLY	1	83		
24	CAM SHAFT	1	54	MAGNETIFLY WHEEL	1	84		
25	PASSIVE 'HEEL	1	55	PISTONRINGFOR AIR (1)	1	85		
26	INLET VALVE CAMROCKER	2	56	PISTONRING (2)	1	86		
27	CYLINDER HEAD	1	57	PISTONRINGE FOR OIL	1	87		
28	EXHAUST VALVE(ZE)	1	58	PISTON	1	88		
29	29 INLET VALVE(ZI)	1	59	OIL SEAL 9115w5525x6	1		89	
30	JUICYLINDERIWA D GASKET	1	60	BEARING 6202		190		

¥ NOTES ON STARTING THE ENGINE

- 1) Take a careful look around to make sure that no obstacles exist within a perimeter of 15m or less around brush cutter.
- 2) Place the body of the brush cutter onto the ground in a flat clear area and
- 3) hold it firmly in place so as to ensure that neither blades nor the throttle come into contact with any obstacles when the engine starts up.



- 4) Place the throttle into the idling position when starting the engine.

- 5) The engine has been adjusted at the factory so that when starting and when in its idle position, the blade does not turn. Should the blade turn when starting or idling, check the throttle cable is not snagged. If not snagged, adjust the idling screw as shown on Page 16.

KICKBACK SAFETY PRECAUTIONS

- 4 Contacting a solid object or obstruction is extremely dangerous and will cause Kick Back reaction causing the operator to lose control of the unit which can result serious or fatal injury.

Avoid kickback at all times by observing the safety precautions below.

1. Before beginning work, clear your working area of any obstacles.
2. Keep a firm grip on both handles.
3. Do not let the blade or trimmer get too close to your feet or not raise themachine above waist height.

■ NOTES ON TRANSPORTATION

1. Make sure the appropriate blade cover is in place
2. When transporting by car, fix the unit firmly using a rope. Do not transport by bicycle or motorcycle because it is dangerous.
3. Never transport the brush cutter over rough roads over long distances without first removing all fuel from the fuel tank, as doing so might cause fuel to leak from the tank.

OPERATION SAFETY PRECAUTIONS

1. Grip the handles of the brush cutter firmly with both hands. When you take a rest, stop the machine.
2. Always be sure to maintain a steady, even posture while working.
3. Maintain the speed of the engine at the level required to perform cuttingwork, and never raise the speed of the engine above the level necessary.
4. If the grass gets caught in the blade during operation, or if you need to check the unit or refuel the tank, always be sure to turn off the engine.
5. If the blade touches a hard object like a stone, immediately stop the engine and check if something is wrong with the blade. If so, replace the blade with new one.
6. If someone calls out while working, always be sure to turn off the engine before turning around.
7. Never touch the spark plug or plug cord while the engine is in operation as this may result in being subjected to an electrical shock.
8. Never touch the silencer, spark plug, or other metallic parts of the engine while the engine is in operation or immediately after shutting down the engine as this may result in serious burns.
9. When you finish cutting in one location and wish to continue work in another spot, turn off the engine prior to moving location.



PART NAME	QTY	NO	PART NAME	(NO)	PART NAME	QTY
1	1	31	SCREW 145.45	61	STRAP CHAMER GASKET	1
2	1	32	—ENGINE COVER	62	THEFIRSTHALF CRANKCASE	1
3	1	33	ADIABATIC USHER	63	ORIENTATIONPI N	1
4	2	34	SCREW M5o2	64	OIL PIPE CLIP	1
5	1	35	ROCKER CHAMBERLID	65	LUBRICATING OIL PIPE	1
6	1	36	RETURE OIL BOARD	66	CARBURETORIN STALL SEAT	1
7	2	37	VALVE LOCK	67	INLET AIR PIPE	2
8	2	38	VALVE SPRING	68	SCREW 115,415	1
9		139	SPARK PLUG	69	CARBURETOR WASHER	1
10	1	40	EXHAUST VALVEROCKER	70	CARBURETOR ASSEMBLY	1
11	2	41	ADJUST SCREW	71	AIR FILTER SHELL	1
12	1	42	INLET VALVE TAPROCKER	72	STARTER SET ASSEMBLY	1
13	2	43	ROCKER SHAFT	73	SCREW M 5*15	1
14	2	44	SCREW M4o8	74	SCREW M 5.30	1
15	1	45	OIL PIPE SHEATH	75	THE SECONDNAL F CRANE CASE	1
16	4	46	SCREW 145.40	76	AIR FILTER SPONGE	4
					AIR FILTER COVER	2

EXPLODED PART DIAGRAM

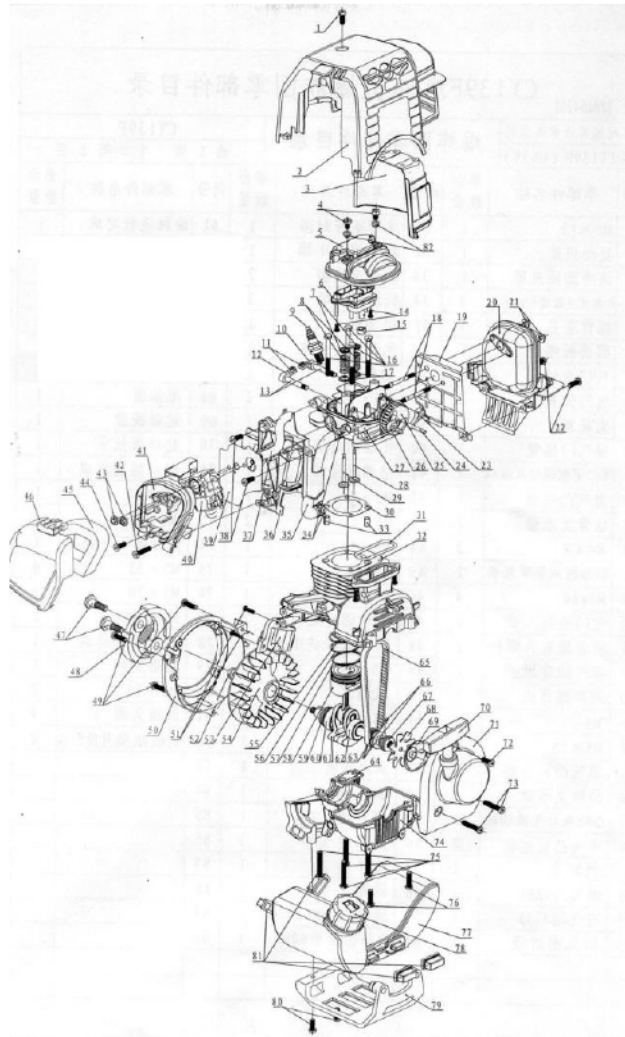

MAINTENANCE SAFETY PRECAUTION

1. Perform the maintenance and checking operations described in this manual at regular intervals. If any parts must be replaced or any maintenance or repair work not described in this manual must be performed, please contact the Eckman Helpline.
2. Under no circumstances should you ever take apart the brush cutter or alter it in any way. Doing so might result in the brush cutter becoming damaged during operation or the brush cutter becoming unable to operate properly. Any modification of this machine is dangerous and will invalidate your guarantee.
3. Always be sure to turn off the engine before performing any maintenance or checking procedures.
4. When sharpening, removing, or re-attaching the blade, be sure to wear sturdy gloves and use only proper tools and equipment to prevent injury.
5. When replacing blade or any other parts, always be sure to use only ECKMAN original products.

THE HANDLE

1. Loosen the 4 bolts on the handle bracket.
2. Insert the right handle (throttle lever is attached) and the left handle assembly into the bracket and retighten the bolts securely.

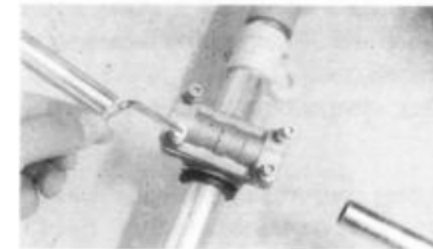

THE SAFETY GUARD

1. Slide the chromed metal guard holder already affixed to the shaft into the recess on the plastic guard.
2. Line up the four holes. Fix and tighten the four bolts using the spanner and hex-hex supplied

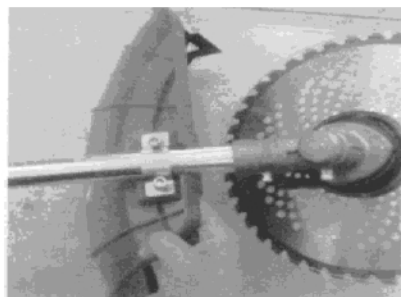

THE METAL BLADE

1. Loosen the blade retainer nut clockwise and remove the blade retainer.
2. You'll need to line up the two holes in the side of the cutting head assembly and insert the hex key in them to keep the blade still



Put the bush and the blade seat onto the end of the shaft then the metalblade into the seat.

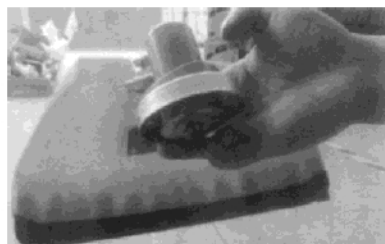

the blade, and keep the machine well protected from the elements to avoid damp and frost.

TECHNICAL SPECIFICATION

Engine Type	4-Stroke, ,
Displacement	47.9 cc
Rate of power	1.49 kW (2 hp)
Pipe	28 MM, Shaft :9T
3-Point Blade	25 cm (10 inches) 25 cm (10 inches)
Tap & Go	Nylon Cutter

SILENCER

1. Remove the silencer, insert a screwdriver into the vent and wipe away any carbon build up. Wipe away any carbon build up on the silencer exhaust vent at the same time.
2. Tighten all screws, bolts, and fittings.
3. Check to see if any oil or grease has worked its way in between the clutchlining and drum, and if it has wipe it away using neat unleaded petrol.
4. Remove the float cabin of the carburetor and clean the inside.

ADJUSTING CARBURETOR

A wrong adjustment may cause damage to your unit. If the engine does not run well after adjusting the carburetor, please contact the Eckman helpline.

IDLE ADJUSTMENT SCREW(F17)

This is the screw to adjust the engine rotation when the throttle lever is set to

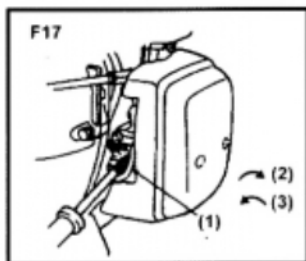

the lowest speed position. If you turn the screw right (clockwise), rotation increases, and left (counterclockwise) it decreases. In case the blade continues to rotate, or engine stops when you return the throttle lever completely to the original position, make readjustment.

- 1) Idle adjustment screw
- 2) High
- 3) Low

ENGINE COOLING FINS

Inspect the fin visually through the cover. If there are dry grass, leaves and mud clogged, contact the power equipment dealer for cleaning it.

MAINTENANCE BEFORE STORAGE

1. Brush off any dirt or debris from the machine, check for any damage or loose parts. Adjust / re-tighten where necessary for the next use.
2. Empty the fuel from the tank, and run the engine until it stops naturally.
3. Remove the spark plug, put a few drops of oil into the cylinder and then pull the recoil starter 2-3 times in order to distribute the oil evenly. Replace the spark plug.
4. Apply anti-rust oil to the metal parts such as the throttle wire, put the cover on

Fit the domed cover, then the securing nut and tighten the nut anti-clockwise.

THE NYLON CUTTER (OPTION)

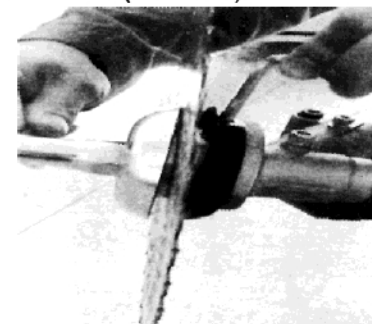

If you use the unit as a grass trimmer follow the instructions below:

1. Loosen the blade retainer nut clockwise and remove the blade retainer.
2. Fit the line cutting head on to the end of the shaft and tighten the cutting head.

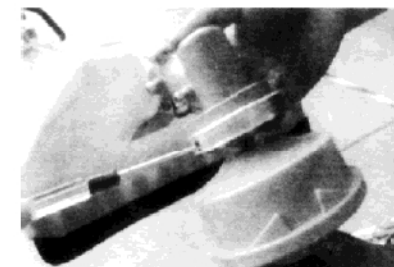

NOTE: Please store the blade retainer and nut in a safe place. **THE SHOULDER**

STRAP

1. Clip the belt hook to the hanging rings on shaft tube.
2. Adjust the length of the belt in order to obtain the most comfortable working position

FUEL



- Petrol is very flammable. Avoid smoking or bringing any flame or sparks near fuel. Use only Unleaded petrol
- Wipe up all spills before starting the engine.
- Make sure to stop the engine and allow it to cool before refueling the unit.

OIL

Oil is a major factor affecting performance and service life. Use 4 stroke automotive detergent oil. SAE 10W-30 is recommended for general use. Other viscosities shown in the chart may be used when the average temperature in your area is within the recommended range.

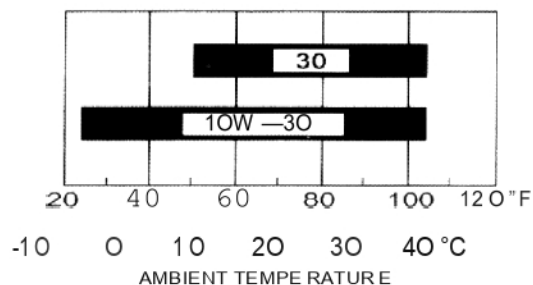

Running the engine with insufficient oil can cause serious engine damage. This is not covered by your warranty!

Be sure to check the engine on a level surface with the engine stopped and cold.

- a. Place the engine with the fuel tank side downward and horizontally on a level surface.
- b. Remove the oil filler cap and check the oil level: it should reach the top of the oil filler neck.
- c. If the level is low, fill to the top of the oil filler neck with the recommended oil.
- d. After every 10 hours of continuous use, check the engine oil level and replenish as required.

- After the spark plug is seated, tighten with a spark plug wrench to compress the washer.

INTAKE AIR COOLING VENT

- Check the intake air cooling vent and the area around the cylinder cooling fins, and remove any debris which has attached itself with a soft brush. Do not use water or chemicals.
- + **Note:** failing to remove debris will cause the silencer to become overheated, which, in turn could cause the brush cutter to over-heat and catch on fire.

GEAR CASE

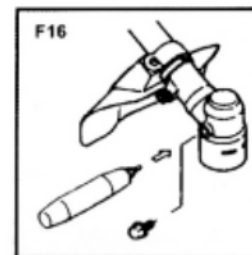

Top up with multi-purpose grease at every 25 hours of use.

Remove the cutter holders to remove old grease (F16). Failure to add lubrication will result in much faster wear and eventual failure!

MAINTENANCE

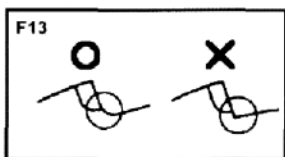

BLADE

- Sharpen each cutting edge with a file and make sure the bottom corner is rounded. (F13)
- Do not cool the blade with water if using a grinder as this may cause cracks in the blade.

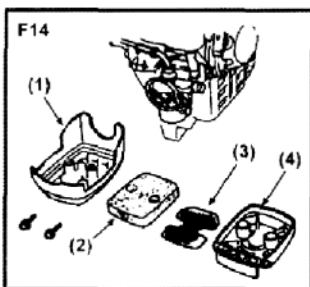

AIR CLEANER

Check and clean the filter element in warm, soapy water as required. Dry completely before installing. If the element is broken or shrunk, replace with a new one. (F14)

- (1) Cover
- (2) Element
- (3) Screen
- (4) Body

A closed air filter will increase fuel consumption while cutting down the engine power.

Never operate the brush cutter without the air filter!

■ FUEL FILTER

Take the filter out of the fueling port using a small wire hook. Disconnect the filter assembly from the fuel pipe and unhook the retainer to disassemble it. Clean the components with neat petrol.

A clogged fuel filter may cause poor acceleration of the engine.

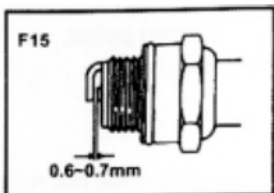

SPARK PLUG

- Remove and inspect the spark plug and clean the electrodes as necessary with brush.
- The spark gap should be adjusted to 0.6-0.7mm(0.024-0.028in).
- Check the spark plug washer is in good condition and thread the spark plug in by hand to prevent cross-threading.

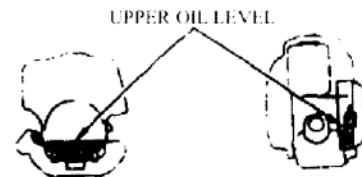

OPERATION

• STARTING THE ENGINE

Before starting the engine, inspect the entire unit for any loose fittings or fuel leaks, and that the cutting attachment is properly installed and securely fastened.

Place the unit on a flat, firm place. Keep the cutting head clear of the ground and everything around it.

1. Place the ignition switch to the on position marked .
2. Place the choke lever upwards to the cold start position (cold start). (Note: This is not required if the engine is already warm.)
3. Push the primer button 8 times until the petrol flows in and out of the discharge hose located above the fuel tank.



4. Pull the recoil starter 2-3 times until you hear the engine starting.



5. Push the choke lever down to the run position.
6. The engine may start, or it may be required to pull on the recoil starter until the engine starts.
7. Allow the engine to run idle for around 10 seconds to let it warm up.
8. To engage the drive, squeeze the safety lever and throttle trigger.
9. Press the throttle trigger lock button for locking and squeeze the safety lever and throttle trigger for unlocking.



STOPPING THE Engine

1. Return the throttle lever to the idling position.

2. Place the ignition switch to the off position as marked.



CUTTING OPERATION

METAL BLADE USAGE

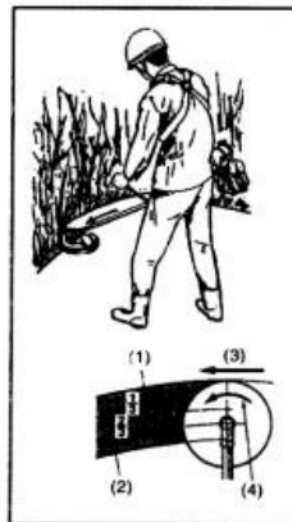

- Always cut by guiding the head from your right to left.
 - A metal blade cuts best up to the point 1/3 from the edge. Use that area for cutting shrubs, tough and thick weeds. For cutting young grass, you can use up to 2/3 from the tip of blade or alternatively fit the nylon grass trimmer attachment.
 - Adjust the engine speed according to what you are cutting. Cut young grass at middle
- (1) **For branches and trees**
 (2) **For Grass and weeds**
 (3) **Direction of cutting**
 (4) **Direction of rotation**

Operating at low speed, and cut shrubs or tough and thickweeds or bramble at high speed.

For branches and trees for grass and weeds Direction of cutting

Direction of rotation

Operating at low speed makes it easier for grass, weeds, or twigs to become caught up in the blades, and also it makes the shaft and clutch wear down more quickly.

NYLON CUTTER USAGE

- Nylon cord consumes approximately 50% more power than when using a metal brush cutter blade.
- If the grass you want to trim is thick, start at the edges and work your way inwards. Do not attempt to cut too much in one go. Do not force the trimmer.